

FWB1353-J

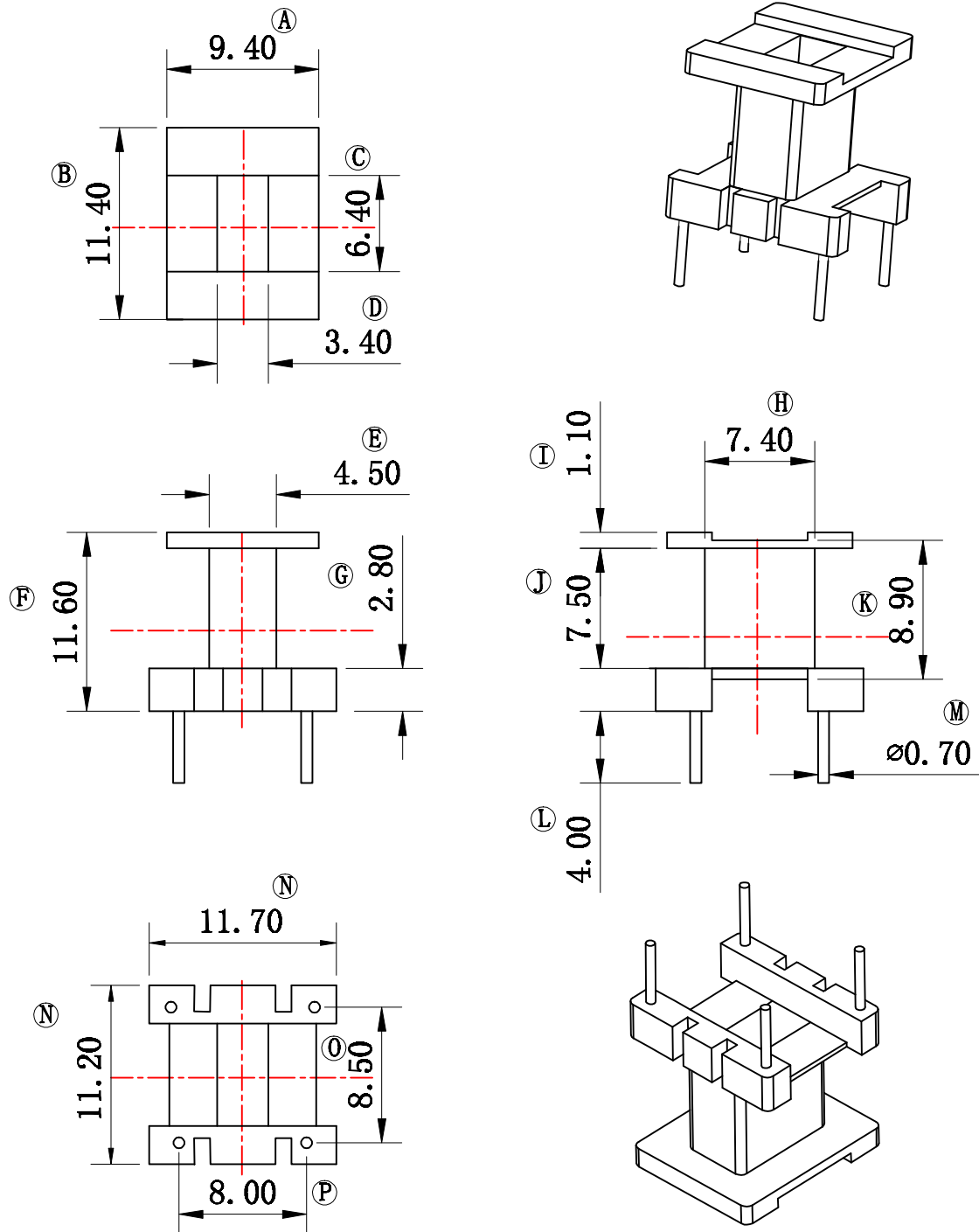

REV	REVISION RECORD	DATE	REV	REVISION RECORD	DATE		
A			C				
B			D				
NAME	EE13 2+2P	MATERIAL	PBT	SCALE	ANGLE	$\pm 1^\circ$	
DRAWING NO.	FWB1353-J	PIN MATERIAL	CP WIRE	UNIT	m/m	REV	A
TOLERANCE OF PIN PITCH ± 0.20				HAINING FERRIWO ELECTRONICS CO.,LTD. TEL: +86-573-87088701 FAX: +86-573-87081130 Web: www.ferriwo.com Email: sales@ferriwo.com			
PIN TENSION LOAD		kg MN	UL REC: 94V-0				
TOLERANCE: 0<L≤4: ±0.2		4<L≤16: ±0.3	16<L≤63: ±0.4				